







KINKIET / WALL LAMP / WANDLEUCHTE

ORBIS 2

szary / grey / grau



-  G9, 2 x 40 W, 2 x 12 W LED *
-  ~ 220-230 V, 50-60 Hz
-  26 x 12 x 10 cm
-  aluminium / aluminium / Aluminium
-  szary / grey / grau
-  31 x 14 x 14 cm
-  netto: 1,4 kg, brutto: 1,55 kg
/ net: 1,4 kg, gross: 1,55 kg
/ netz: 1,4 kg, brutto: 1,55 kg

 IP20
 

Podzespoły zastosowane w oprawach:

- oprawka G9, 2 A, 250 V
- przewód przyłączeniowy 0,75 mm²
- złączki zaciskowe

/ Components used in luminaries:

- holder G9, 2 A, 250 V
- connection cable 0,75 mm²
- compression fittings

/ Bauelemente der Fassungen:

- fassung G9, 2 A, 250 V
- elektrische Leitung 0,75 mm²
- Klemmen

* Źródło światła nie jest w komplecie / Light bulb not included / Leuchtmittel nicht inkl.



SL.0661

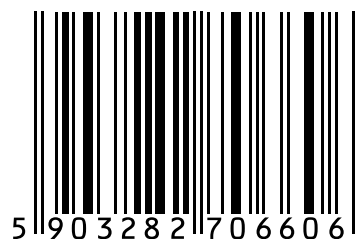
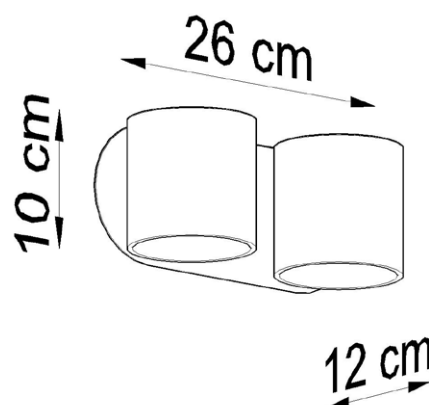

Made in EU