







KINKIET / WALL LAMP / WANDLEUCHTE

QUAD 2

biały / white / weiß



-  G9, 2 x 40 W, 2 x 12 W LED *
-  ~ 220-230 V, 50-60 Hz
-  26 x 12 x 11 cm
-  aluminium / aluminium / Aluminium
-  biały / white / weiß
-  31 x 14 x 14 cm
-  netto: 0,95 kg, brutto: 1,10 kg
/ net: 0,95 kg, gross: 1,10 kg
/ netz: 0,95 kg, brutto: 1,10 kg



Podzespoły zastosowane w oprawach:

- oprawka G9, 2 A, 250 V
- przewód przyłączeniowy 0,75 mm²
- złączki zaciskowe

/ Components used in luminaries:

- holder G9, 2 A, 250 V
- connection cable 0,75 mm²
- compression fittings

/ Bauelemente der Fassungen:

- fassung G9, 2 A, 250 V
- elektrische Leitung 0,75 mm²
- Klemmen



SL.0656

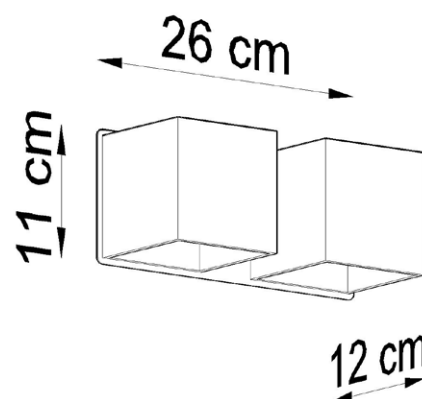

* Źródło światła nie jest w komplecie / Light bulb not included / Leuchtmittel nicht inkl.



Made in EU