







PLAFON / PLAFOND / PLAFOND

DIREZIONE 1

czarny / black / schwarz



-  GU10, 1 x 40 W, 1 x 12 W LED *
-  ~ 220-230 V, 50-60 Hz
-  8 x 8 x 20 cm
-  stal / steel / Stahl
-  czarny / black / schwarz
-  31 x 17 x 12 cm
-  netto: 0,25 kg, brutto: 0,40 kg
/ net: 0,25 kg, gross: 0,40 kg
/ netz: 0,25 kg, brutto: 0,40 kg



Podzespoły zastosowane w oprawach:

- oprawka GU10, 2 A, 250 V
- przewód przyłączeniowy 0,75 mm²
- złączki zaciskowe

/ Components used in luminaries:

- holder GU10, 2 A, 250 V
- connection cable 0,75 mm²
- compression fittings

/ Bauelemente der Fassungen:

- fassung GU10, 2 A, 250 V
- elektrische Leitung 0,75 mm²
- Klemmen



SL.0499

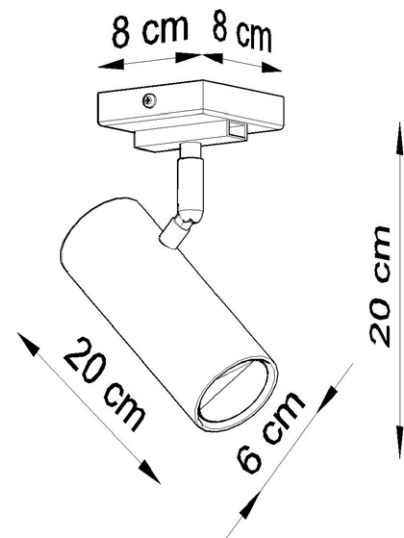

* Źródło światła nie jest w komplecie / Light bulb not included / Leuchtmittel nicht inkl.



Made in EU