







KINKIET / WALL LAMP / WANDLEUCHE

ORBIS

beton / concrete / Beton



-  G9, 1 x 40 W, 1 x 12 W LED *
-  ~ 220-230 V, 50-60 Hz
-  10 x 12 x 10 cm
-  beton / concrete / Beton
-  szary / grey / grau
-  13 x 13 x 13 cm
-  netto: 0,35 kg, brutto: 0,50 kg
/ net: 0,35 kg, gross: 0,50 kg
/ netz: 0,35 kg, brutto: 0,50 kg



Podzespoły zastosowane w oprawach:

- oprawka G9, 2 A, 250 V
- przewód przyłączeniowy 0,75 mm²
- złączki zaciskowe

/ Components used in luminaries:

- holder G9, 2 A, 250 V
- connection cable 0,75 mm²
- compression fittings

/ Bauelemente der Fassungen:

- fassung G9, 2 A, 250 V
- elektrische Leitung 0,75 mm²
- Klemmen



SL.0486

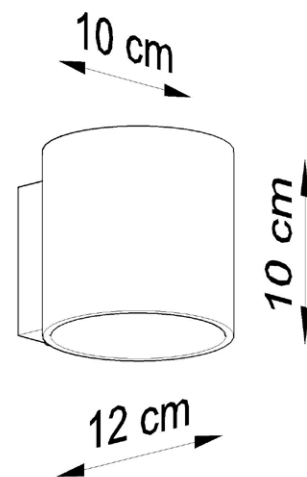

* Źródło światła nie jest w komplecie / Light bulb not included / Leuchtmittel nicht inkl.



Made in EU