







KINKIET / WALL LAMP / WANDLEUCHTE

QUAD 1

biały / white / weiß



-  G9, 1 x 40 W, 1 x 12 W LED *
-  ~ 220-230 V, 50-60 Hz
-  10 x 12 x 10 cm
-  aluminium / aluminium / Aluminium
-  biały / white / weiß
-  13 x 13 x 13 cm
-  netto: 0,5 kg, brutto: 0,65 kg
/ net: 0,5 kg, gross: 0,65 kg
/ netz: 0,5 kg, brutto: 0,65 kg

 IP20
 

Podzespoły zastosowane w oprawach:

- oprawka G9, 2 A, 250 V
- przewód przyłączeniowy 0,75 mm²
- złączki zaciskowe

/ Components used in luminaries:

- holder G9, 2 A, 250 V
- connection cable 0,75 mm²
- compression fittings

/ Bauelemente der Fassungen:

- fassung G9, 2 A, 250 V
- elektrische Leitung 0,75 mm²
- Klemmen



SL.0059

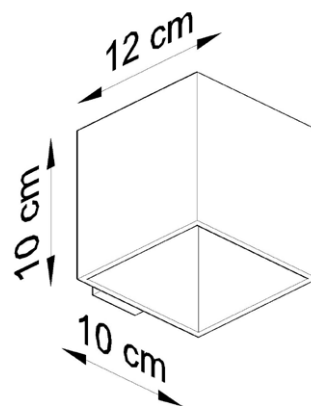

* Źródło światła nie jest w komplecie / Light bulb not included / Leuchtmittel nicht inkl.



Made in EU