







KINKIET CERAMICZNY / WALL LAMP CERAMIC / WANDLEUCHTE KERAMIK

# MAGNET



-  E27, 1 x 60 W, 1 x 15 W LED \*
-  ~ 220-230 V, 50-60 Hz
-  36 x 15 x 7,5 cm
-  ceramika / ceramic / Keramik
-  biały / white / weiß
-  40 x 20 x 15 cm
-  netto: 1,65 kg, brutto: 1,80 kg  
/ net: 1,65 kg, gross: 1,80 kg  
/ netz: 1,65 kg, brutto: 1,80 kg

 IP20  
 

Podzespoły zastosowane w oprawach:

- oprawka E27, 4 A, 250 V

/ Components used in luminaries:

- holder E27, 4 A, 250 V

/ Bauelemente der Fassungen:

- fassung E27, 4 A, 250 V



\* Źródło światła nie jest w komplecie / Light bulb not included / Leuchtmittel nicht inkl.

SL.0034

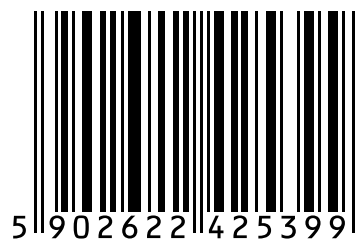
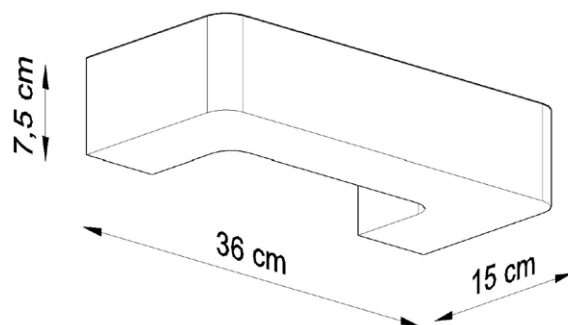

Made in EU